

# AKURA UP



# AKURA UP

A soletta interna al foro  
To the inner slab to the hole  
A' semelle intérieure du trou

**AKURA 60 UP**

PIANTA

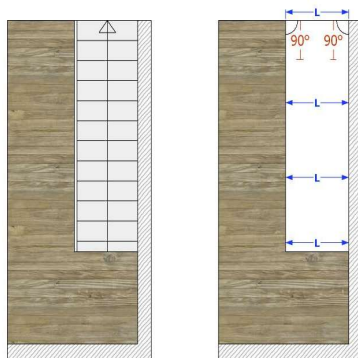

PROSPETTO

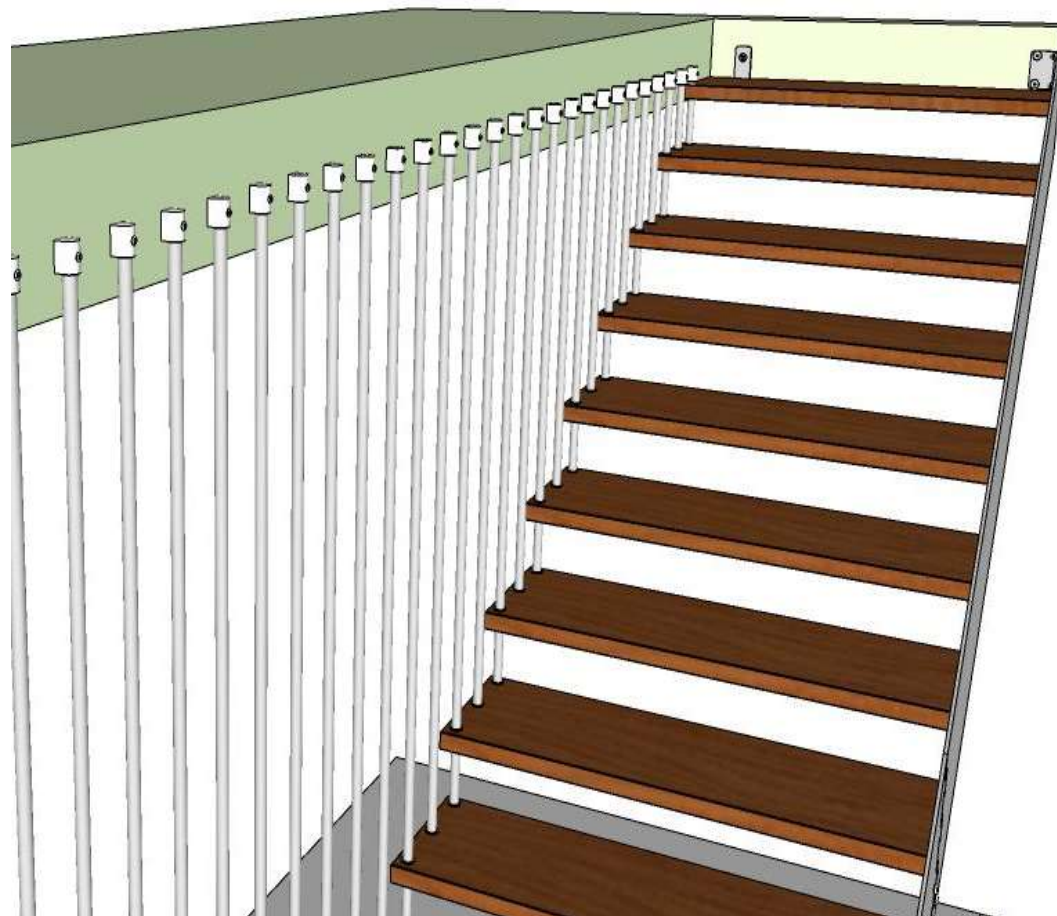
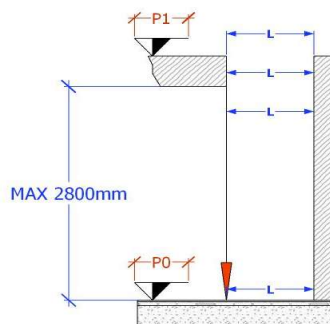

**AKURA 60 UP**

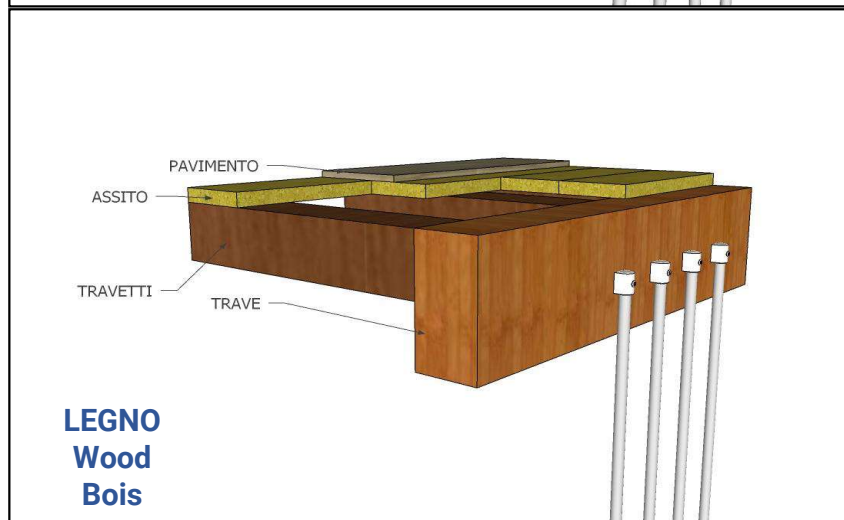
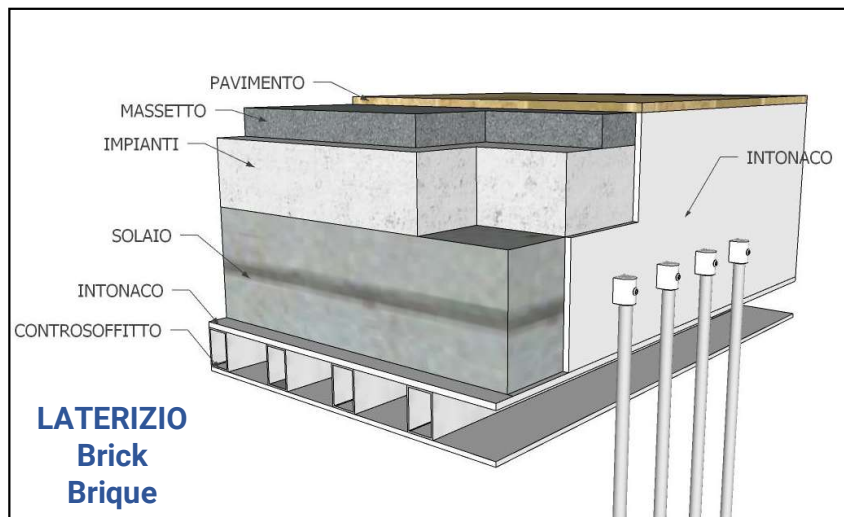

**Tipologie di solai e di fissaggi**  
Types of slabs and fixings  
Types de dalles et de fixations

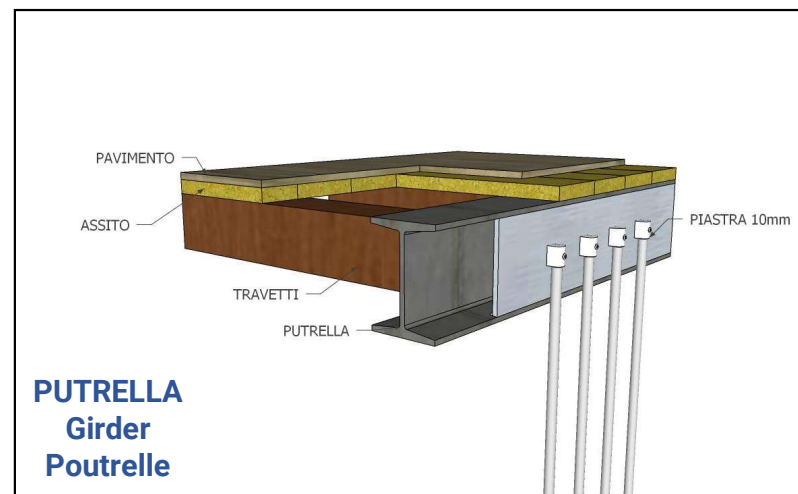

## AKURA 60 UP

PIANTA

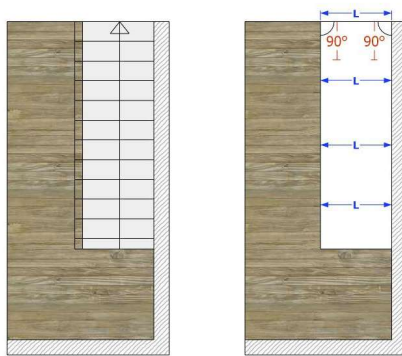

PROSPETTO

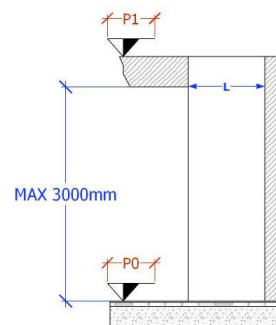

A soffitto con binario esterno foro  
Ceiling with external rail hole  
Plafond avec rail extérieur trou

**AKURA 60 UP**

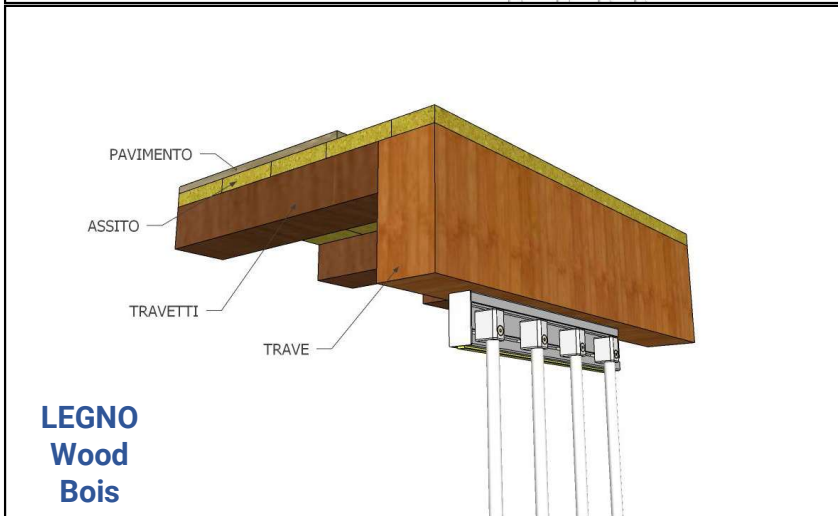
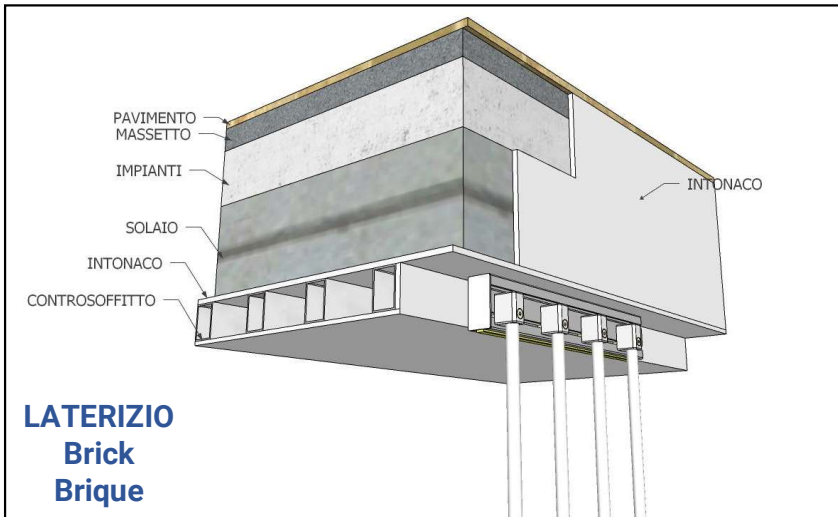

**Tipologie di solai e di fissaggi**  
Types of slabs and fixings  
Types de dalles et de fixations

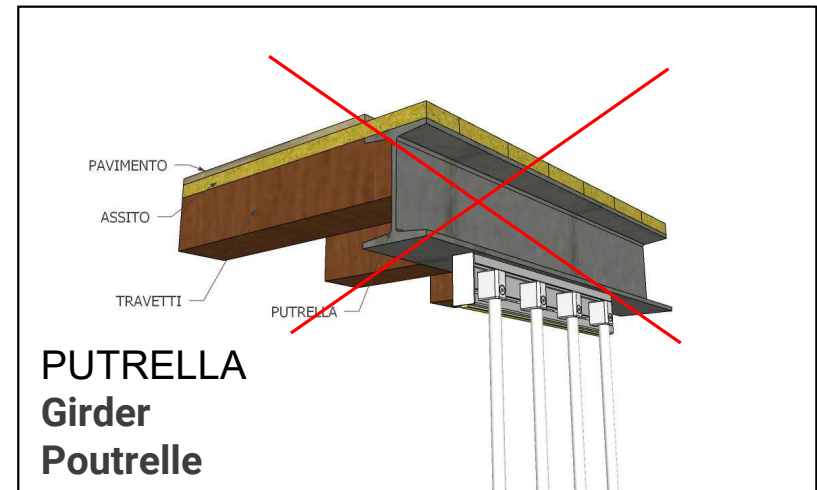

# AKURA UP

## OPTIONAL

### Corrimano a muro

Wall handrail  
Main courante murale  
Wandhandlauf  
Pasamanos de pared



### Angolo per pilastro (max 3 gradini)

Corner for Pillar (max 3 steps)  
Angle pour Poteau (max 3 marches)  
Winkel pro Säule (Max 3 Sufen)  
Angulo por pilar (máximo 3 escalones)

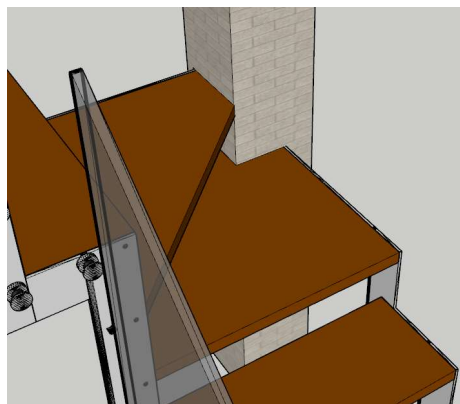

**Soglia**  
Threshold  
Seuil  
Schwellenwert  
Umbral

